

LÄGERPLAN

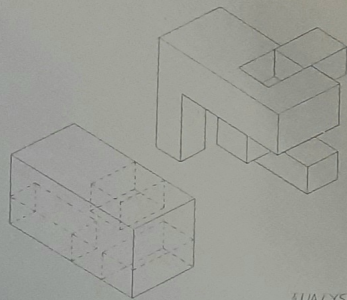

ANALYSE

BADHAUS

DEKA WS 2021 E2D
BETREUER TIMO PLACHTA
EVA WITTMANN

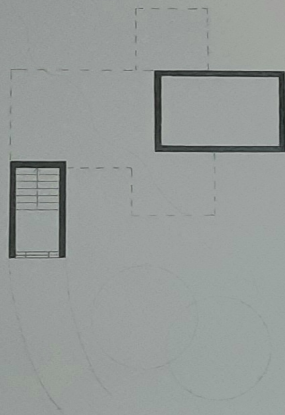

GRUNDRISS EG

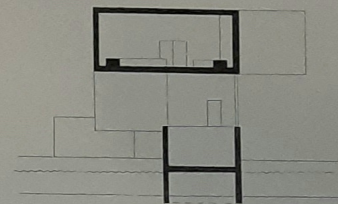

SCHNITT A

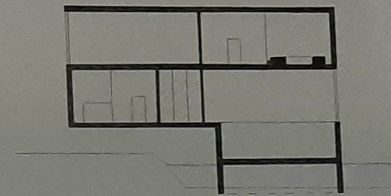

SCHNITT B

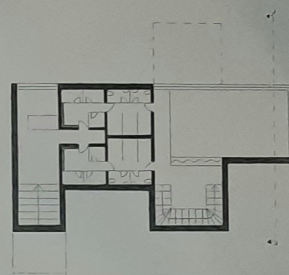

GRUNDRISS 1. OG



GRUNDRISS 2. OG

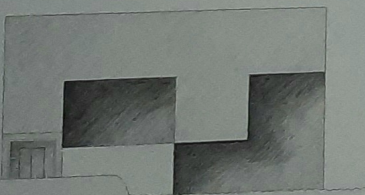

ANSICHT SÜD

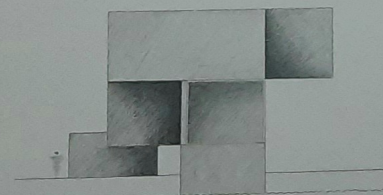

ANSICHT ÖST

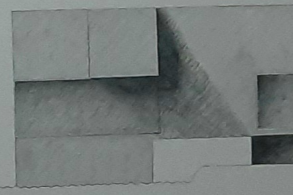

ANSICHT NORD

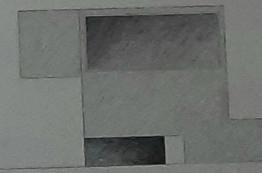

ANSICHT WEST

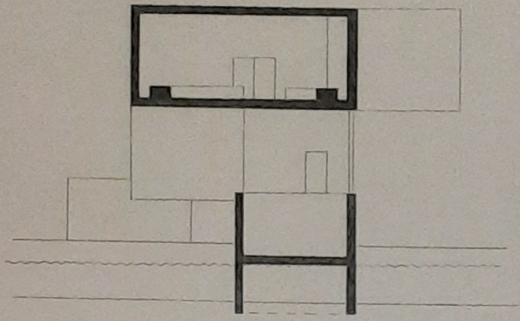

SCHNITT A

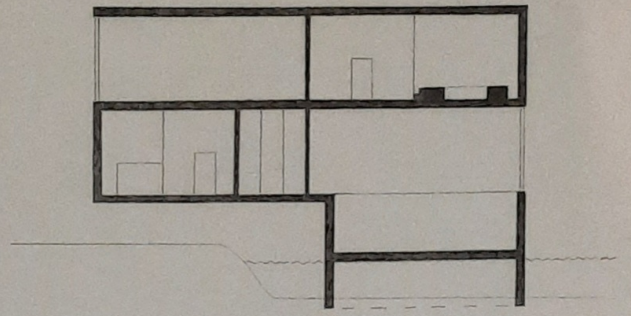

SCHNITT B

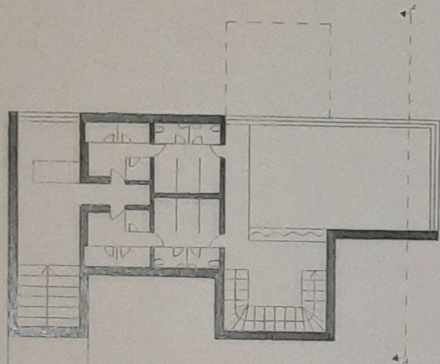

GRUNDRISS 1.05

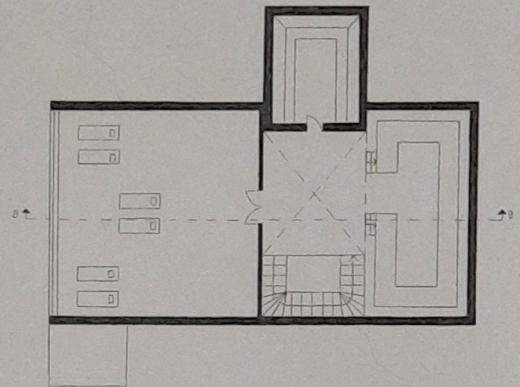

GRUNDRISS 2.05

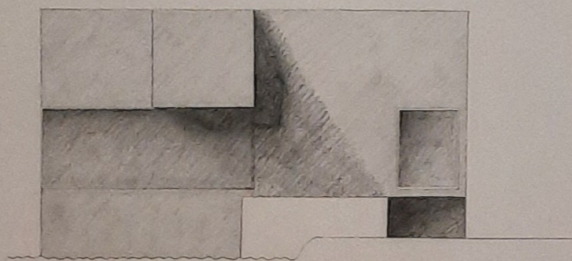

ANSICHT NORD

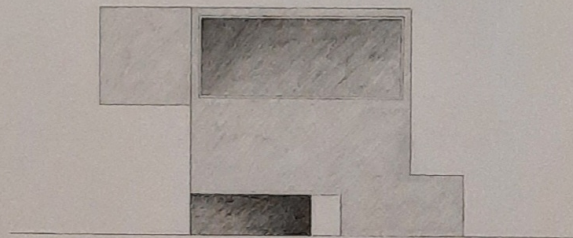

ANSICHT WEST

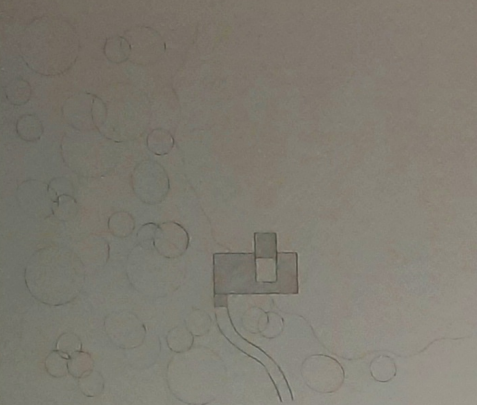

LAGEPLAN

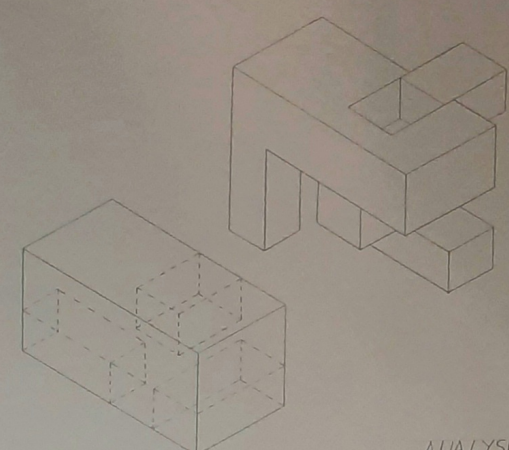

ANALYSE

B
A
D
E
H
A
U
S

DEMI WS 20/21 E2D
BETREUER TIMO PLACHTA
EVA WITTMANN

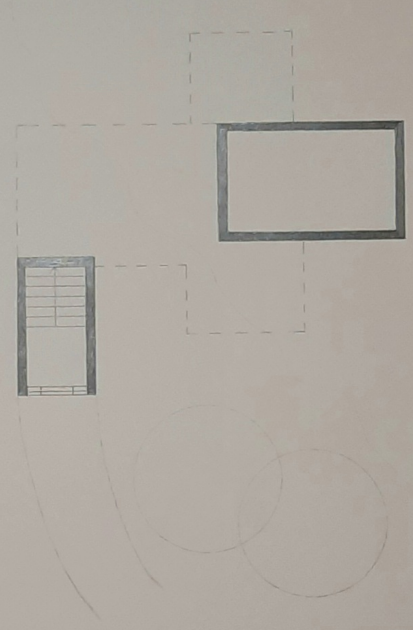

GRUNDRISS EG

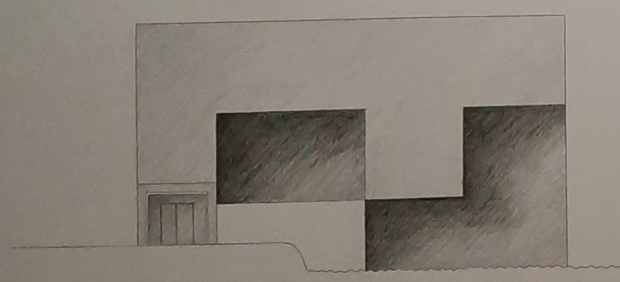

AUSICHT SÜD

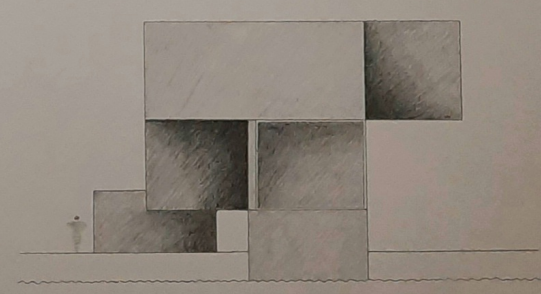

AUSICHT OST

